

Standard & Gel Loading

Macro Tip

Volume: 1000-5000 μ l

For use with but not limited to:

Finnpipette®
SMI

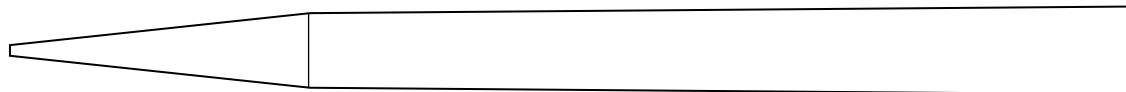

Product No.	Color	Package Type	Qty/ Unit	Qty/ Case	Price/ Unit
095	Natural	Bagged	250	2,500	\$7.50
095-S	Natural	Single Wrap - S	250	1,250*	14.38

Volume: 5000 μ l

For use with but not limited to:

Biohit Proline®
Eppendorf® Research
Jencons Sealpette®
Labpette™

Standard & Extra Long

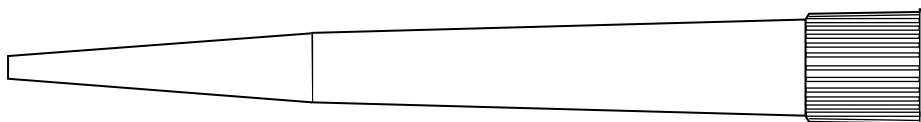

Product No.	Color	Package Type	Qty/ Unit	Qty/ Case	Price/ Unit
096	Natural	Bagged	250	2,500	\$ 7.50
096-NXL	Natural	Bagged	250	2,500	8.30

Volume: 1-10ml

For use with but not limited to:

Pipetman®

10ml Tip with graduations at 1.0ml intervals

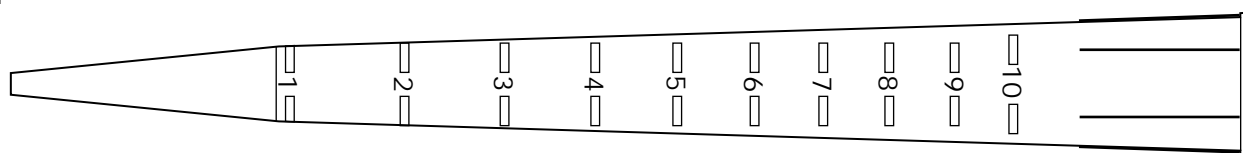

Product No.	Color	Package Type	Qty/ Unit	Qty/ Case	Price/ Unit
097	Natural	Bagged	200	2,000	\$14.25

Volume: 100-1000 μ l

For use with but not limited to:

Biopet
Clay Adams® Selectapette®

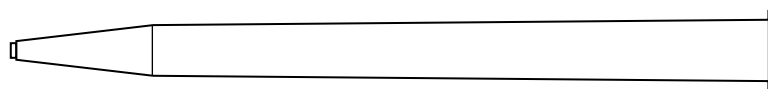

Product No.	Color	Package Type	Qty/ Unit	Qty/ Case	Price/ Unit
100	Natural	Bagged	500	5,000	\$7.00
100-R	Natural	Spec. 250 Tip Rack	250	5,000	5.78

Pipet Tips

1

Standard & Gel Loading

Volume: 0.1-10µl

For use with but not limited to:

Eppendorf® Reference and Research

Biohit Proline® (0.2 - 10µl)

Jencons Sealpette®

Labpette™

Nichiryo

Oxford-Benchmate®

Pipetman®

Ultra Micro "Nano Tip"

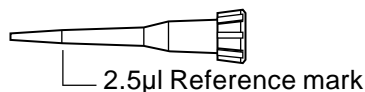

Product No.	Color	Package Type	Qty/ Unit	Qty/ Case	Price/ Unit
101	Natural	Bagged	1,000	10,000	\$9.15
101-96R	Natural	96 Tip Rack	960	4,800	18.50
101-96RS	Natural	96 Tip Rack - S	960	4,800	20.50

Volume: 0.1-10µl

For use with but not limited to:

Pipetman®

Biohit Proline® (0.2 - 10µl)

Eppendorf® Reference and Research

Jencons Sealpette®

Labpette™

Nichiryo

Oxford-Benchmate®

Rainin

Socorex

Ultra Micro Tip

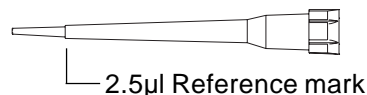

Product No.	Color	Package Type	Qty/ Unit	Qty/ Case	Price/ Unit
102	Natural	Bagged	1,000	10,000	\$9.15
H-102-96R	Natural	H 96 Tip Rack	960	4,800	18.50
H-102-96RS	Natural	H 96 Tip Rack - S	960	4,800	21.50

Volume: 0.1-10µl

For use with but not limited to:

Pipetman®

Biohit Proline® (0.2 - 10µl)

Eppendorf® Reference and Research

Jencons Sealpette®

Labpette™

Nichiryo

Oxford-Benchmate®

Ultra Micro Gel Loading Tip



Product No.	Color	Package Type	Qty/ Unit	Qty/ Case	Price/ Unit
103	Natural	Bagged	1,000	10,000	\$18.33
103-R204	Natural	204 Tip Rack	1,020	5,100	26.61
103-R204S	Natural	204 Tip Rack- S	1,020	5,100	28.83

Volume: 0.1-10µl

For use with but not limited to:

Pipetman®

Biohit Proline® (0.2 - 10µl)

Eppendorf® Reference and Research

Jencons Sealpette®

Labpette™, 8 & 12 Channel

Nichiryo

Oxford-Benchmate®

Rainin EDP2™

Ultra Micro Tip

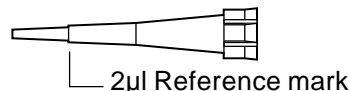

Product No.	Color	Package Type	Qty/ Unit	Qty/ Case	Price/ Unit
104	Natural	Bagged	1,000	10,000	\$9.15
104-96R	Natural	96 Tip Rack	960	4,800	18.50
104-96RS	Natural	96 Tip Rack - S	960	4,800	20.50
H-104-96R	Natural	H 96 Tip Rack	960	4,800	18.50
H-104-96RS	Natural	H 96 Tip Rack-S	960	4,800	20.50
HRI-104	Natural	Insert-Mini H 96 Tip Rack	480	4,800	8.25

8

w - with
w/o - without

H - Hinged
S - Sterile

* - may be purchased by the unit

Standard & Gel Loading

Volume: 5-200 μ l

For use with but not limited to:



Titertek®

Costar®

Finnpipette®

Nichiryo

MLA®

Oxford-Benchmate®

Pipetman®

Product No.	Color	Package Type	Qty/ Unit	Qty/ Case	Price/ Unit
105	Natural	Bagged	1,000	10,000	\$9.15
105-96R	Natural	96 Tip Rack	960	4,800	17.50
105-96RS	Natural	96 Tip Rack - S	960	4,800	19.50
105-R480	Natural	Q-Stack ⁵	960	4,800	14.40
105-R480S	Natural	Q-Stack ⁵ - S	480	4,800	8.38

Volume: 5-300 μ l

For use with but not limited to:

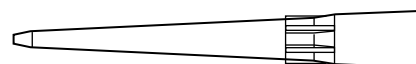

Titertek®

Costar®

Finnpipette®

Nichiryo

Oxford-Benchmate®

Sara-Pette®

Product No.	Color	Package Type	Qty/ Unit	Qty/ Case	Price/ Unit
106	Natural	Bagged	1,000	10,000	\$10.15
106-96R	Natural	96 Tip Rack	960	4,800	18.50
106-96RS	Natural	96 Tip Rack - S	960	4,800	20.50

Volume: 1-300 μ l

For use with but not limited to:

Graduations at 10, 50, 100 & 200 μ l



Titertek®

Biohit Proline®

Costar®

Finnpipette®

Jencons Sealpette®

Labpette™, 8 & 12 Channel

Nichiryo

Oxford-Benchmate®

Pipetman® (P-200)

Product No.	Color	Package Type	Qty/ Unit	Qty/ Case	Price/ Unit
108-G	Natural	Bagged	1,000	10,000	\$10.15
108-96RG	Natural	96 Tip Rack	960	4,800	18.50
108-96RGS	Natural	96 Tip Rack - S	960	4,800	20.50

Volume: 5-300 μ l

For use with but not limited to:

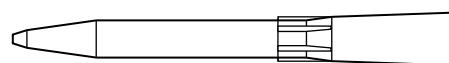

Titertek®

Biohit Proline®

Finnpipette®

Jencons Sealpette®

Nichiryo

Oxford-Benchmate®

Pipetman®

Sara-Pette®

Socorex

Product No.	Color	Package Type	Qty/ Unit	Qty/ Case	Price/ Unit
109	Natural	Bagged	1,000	10,000	\$10.15
109-96R	Natural	96 Tip Rack	960	4,800	18.50
109-96RS	Natural	96 Tip Rack - S	960	4,800	20.50

Pipet Tips

1

Standard & Gel Loading

Standard Yellow Tip (Natural also available)

Volume: 1-200µl

For use with but not limited to:

Pipetman®

Costar® Onepette, 8 & 12 Pette®
Eppendorf®
Finnpipette®
Labpette™, 8 & 12 Channel
Nichiryo
Oxford-Benchmate®
Rainin EDP2™
Socorex
Titertek® Digital
Volac

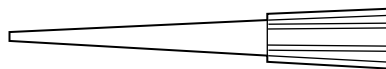

Product No.	Yellow	Natural	Package Type	Qty/ Unit	Qty/ Case	Price/ Unit
110		110-N	Bagged	1,000	10,000	\$9.15
110-R		110-RN	Stack Rack - 200	1,000	10,000	14.75
110-R200		110-R200N	200 Tip Rack	1,000	10,000	18.50
110-R200S		110-R200NS	200 Tip Rack - S	1,000	10,000	21.75
110-96R		110-96RN	96 Tip Rack	960	4,800	17.50
110-96RS		110-96RNS	96 Tip Rack - S	960	4,800	19.50
110-S		110-NS	Single Wrap - S	500	5,000*	14.50
110-R480		110-N-R480	Q-Stack ⁵	960	4,800	14.40
110-R480S		110-N-R480S	Q-Stack ⁵ - S	480	4,800	8.38
H-110-96R		H-110-96RN	H 96 Tip Rack	960	4,800	17.50
H-110-96RS		H-110-96RNS	H 96 Tip Rack - S	960	4,800	19.50
HRI-110		HRI-110-N	Insert for H 96 Tip Rack	480	4,800	8.00

Volume: 1-200µl

For use with but not limited to:

Pipetman®

Costar® Onepette, 8 & 12 Pette®
Eppendorf®
Finnpipette®
Labpette™, 8 & 12 Channel
Nichiryo
Oxford-Benchmate®
Rainin EDP2™
Socorex
Titertek® Digital
Volac

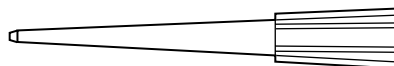

Beveled Orifice Tip (See #113-G for Graduated Version)

Product No.	Yellow	Natural	Package Type	Qty/ Unit	Qty/ Case	Price/ Unit
110-B		110-BN	Bagged	1,000	10,000	\$9.15
110-RB		110-RBN	Stack Rack - 200	1,000	10,000	14.75
110-R200B		110-R200BN	200 Tip Rack	1,000	10,000	18.50
110-R200BS		110-R200BNS	200 Tip Rack - S	1,000	10,000	21.75
110-96RB		110-96RBN	96 Tip Rack	960	4,800	17.50
110-96RBS		110-96RBNS	96 Tip Rack - S	960	4,800	19.50
110-BS		110-BNS	Single Wrap - S	500	5,000*	14.50
110-B-R480		110-BN-R480	Q-Stack ⁵	960	4,800	14.40
110-B-R480S		110-BN-R480S	Q-Stack ⁵ - S	480	4,800	8.38
H-110-96RB		H-110-96RBN	H 96 Tip Rack	960	4,800	17.50
H-110-96RBS		H-110-96RBNS	H 96 Tip Rack - S	960	4,800	19.50
HRI-110-B		HRI-110-BN	Insert for H 96 Tip Rack	480	4,800	8.00

Volume: 1-250µl

For use with but not limited to:

Pipetman®

Costar® Onepette, 8 & 12 Pette®
Eppendorf®
Finnpipette®
Labpette™, 8 & 12 Channel
Nichiryo
Oxford-Benchmate®
Rainin EDP2™
Socorex
Titertek® Digital
Volac

Thin Wall Orifice Tip

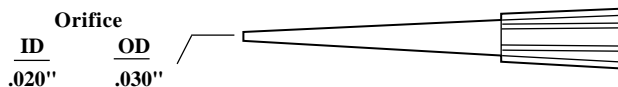

Product No.	Color	Package Type	Qty/ Unit	Qty/ Case	Price/ Unit
TW110-N	Natural	Bagged	1,000	10,000	\$9.15
TW110-96RN	Natural	96 Tip Rack	960	4,800	17.50
TW110-96RNS	Natural	96 Tip Rack - S	960	4,800	19.50
H-TW110-96RN	Natural	H 96 Tip Rack	960	4,800	17.50
H-TW110-96RNS	Natural	H 96 Tip Rack - S	960	4,800	19.50
HRI-TW110-N	Natural	Insert for H 96 Tip Rack	480	4,800	8.00

10

w - with
w/o - without

H - Hinged
S - Sterile

* - may be purchased by the unit

Standard & Gel Loading

Extra Long Tip to ensure maximum sampling

Volume: 1-200µl

For use with but not limited to:

Pipetman®

Costar® Onepette

Eppendorf®

Finnpipette®

Labpette™

Nichiryo

Oxford-Benchmate®

Rainin EDP2™

Volac

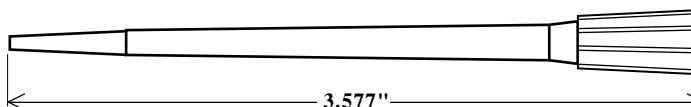

Product No.	Color	Package Type	Qty/ Unit	Qty/ Case	Price/ Unit
110-NXL	Natural	Bagged	1,000	5,000	\$13.00
110-NXL-R204	Natural	204 Tip Rack	1,632	4,896	47.00
110-NXL-R204S	Natural	204 Tip Rack - S	1,632	4,896	50.25
110-NXL-S	Natural	Single Wrap - S	250	2,500*	8.50

Standard Blue Tip (Natural also available) (See #112-G for Graduated Version)

Volume: 101-1000µl

For use with but not limited to:

Pipetman®

Costar®

Eppendorf®

Finnpipette®

Nichiryo

Oxford-Benchmate®

Rainin EDP2™

SMI Airpette®

Socorex

Titertek®

Volac

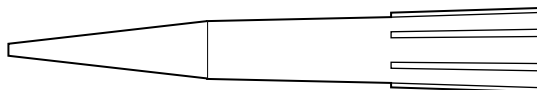

Product No.		Package Type	Qty/ Unit	Qty/ Case	Price/ Unit
<i>Blue</i>	<i>Natural</i>				
111	111-N	Bagged	1,000	10,000	\$10.35
111-R	111-RN	Stack Rack - 100	1,000	5,000	17.30
111-R100	111-R100N	100 Tip Rack	1,000	5,000	21.00
111-R100S	111-R100NS	100 Tip Rack - S	1,000	5,000	23.50
111-S	111-NS	Single Wrap - S	500	5,000*	17.00
H-111-R100	H-111-R100N	H 100 Tip Rack	1,000	5,000	22.50
H-111-R100S	H-111-R100NS	H 100 Tip Rack - S	1,000	5,000	25.50

Extra Long Tip to ensure maximum sampling

Volume: 101-1000µl

For use with but not limited to:

Pipetman®

Costar®

Eppendorf®

Finnpipette®

Nichiryo

Oxford-Benchmate®

Rainin EDP2™

SMI Airpette®

Socorex

Titertek®

Volac

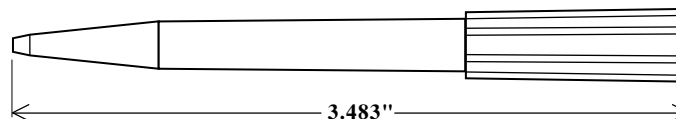

Product No.		Package Type	Qty/ Unit	Qty/ Case	Price/ Unit
<i>Blue</i>	<i>Natural</i>				
111-XL	111-NXL	Bagged	1,000	10,000	\$10.55
111-XL-R	111-NXL-R	Stack Rack - 100	1,000	5,000	17.50
111-XL-R100	111-NXL-R100	100 Tip Rack	1,000	5,000	21.20
111-XL-R100S	111-NXL-R100S	100 Tip Rack - S	1,000	5,000	23.70
111-XLS	111-NXLS	Single Wrap - S	500	5,000*	17.20

Standard & Gel Loading

Graduations at 250, 500 & 1,000µl

Volume: 101-1000µl

For use with but not limited to:

Pipetman®
 Costar®
 Eppendorf®
 Finnpiquette®
 Nichiryo
 Oxford-Benchmate®
 Rainin EDP2™
 SMI Airpette®
 Socorex
 Titertek®
 Volac

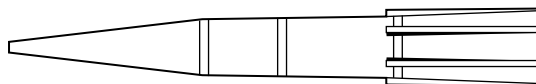

Product No.		Package Type	Qty/ Unit	Qty/ Case	Price/ Unit
<i>Blue</i>	<i>Natural</i>				
112-G	112-GN	Bagged	1,000	10,000	\$10.85
112-RG	112-RGN	Stack Rack - 100	1,000	5,000	17.80
112-R100G	112-R100GN	100 Tip Rack	1,000	5,000	21.50
112-R100GS	112-R100GNS	100 Tip Rack - S	1,000	5,000	24.00
112-GS	112-GNS	Single Wrap - S	500	5,000*	18.00

Beveled Orifice Tip with graduations at 10, 50 & 100µl

Volume: 1-200µl

For use with but not limited to:

Pipetman®
 Costar® Onepette, 8 & 12 Pette®
 Eppendorf®
 Finnpiquette®
 Labpette™, 8 & 12 Channel
 MLA®
 Nichiryo
 Oxford-Benchmate®
 Rainin EDP2™
 Socorex
 Titertek® Digital
 Volac

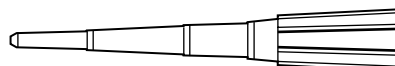

Product No.		Package Type	Qty/ Unit	Qty/ Case	Price/ Unit
<i>Yellow</i>	<i>Natural</i>				
113-G	113-GN	Bagged	1,000	10,000	\$9.65
113-RG	113-RGN	Stack Rack - 200	1,000	10,000	15.25
113-R200G	113-R200GN	200 Tip Rack	1,000	10,000	19.00
113-R200GS	113-R200GNS	200 Tip Rack - S	1,000	10,000	22.25
113-96RG	113-96RGN	96 Tip Rack	960	4,800	18.00
113-96RGS	113-96RGNS	96 Tip Rack - S	960	4,800	20.00
113-GS	113-GNS	Single Wrap - S	500	5,000*	15.25
113-G-R480	113-GN-R480	Q-Stack ⁵	960	4,800	14.40
113-G-R480S	113-GN-R480S	Q-Stack ⁵ - S	480	4,800	8.38
H-113-96RG	H-113-96RGN	H 96 Tip Rack	960	4,800	18.00
H-113-96RGS	H-113-96RGNS	H 96 Tip Rack - S	960	4,800	20.00
HRI-113-G	HRI-113-GN	Insert for H 96 Tip Rack	480	4,800	8.50

Standard & Gel Loading

Ultra Micro Tip

Volume: 0.5-10µl

For use with but not limited to:

Eppendorf®

Labpette™

Nichiryo

Oxford-Benchmate®

Socorex

Titertek® Plus

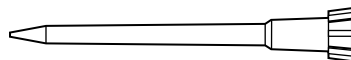

Product No.	Color	Package Type	Qty/ Unit	Qty/ Case	Price/ Unit
114	Natural	Bagged	1,000	10,000	\$9.15
114-R100	Natural	100 Tip Rack	1,000	5,000	17.50
114-R100S	Natural	100 Tip Rack - S	1,000	5,000	19.50
114-S	Natural	Single Wrap - S	500	5,000*	14.50
H-114-96R	Natural	H 96 Tip Rack	960	4,800	18.00
H-114-96RS	Natural	H 96 Tip Rack - S	960	4,800	20.00

Volume: 1-200µl

For use with but not limited to:

Eppendorf®

Brinkman -Transferpette®

Costar®

Finnpipette®

Labpette™, 8 & 12 Channel

Nichiryo

Oxford-Benchmate®

Socorex



Product No.	Color	Package Type	Qty/ Unit	Qty/ Case	Price/ Unit
115	115-N	Bagged	1,000	10,000	\$9.15
115-R	115-RN	Stack Rack - 200	1,000	10,000	14.75
115-R200	115-R200N	200 Tip Rack	1,000	10,000	18.50
115-R200S	115-R200NS	200 Tip Rack - S	1,000	10,000	21.75
115-96R	115-96RN	96 Tip Rack	960	4,800	17.50
115-96RS	115-96RNS	96 Tip Rack - S	960	4,800	19.50
115-S	115-NS	Single Wrap - S	500	5,000*	14.50

Volume: 1-200µl

For use with but not limited to:

Eppendorf®

Finnpipette®

Extra Long Tip *to ensure maximum sampling*

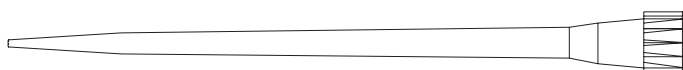

Product No.	Color	Package Type	Qty/ Unit	Qty/ Case	Price/ Unit
115-NXL	Natural	Bagged	1,000	5,000	\$13.00
115-NXL-R100	Natural	100 Tip Rack	800	4,000	23.50
115-NXL-R100S	Natural	100 Tip Rack - S	800	4,000	26.75
115-NXLS	Natural	Single Wrap - S	250	2,500*	8.50

Pipet Tips

1

Standard & Gel Loading

Volume: 101-1000µl

For use with but not limited to:

Eppendorf®
 Biohit Proline®
 Finnpipette®
 Jencons Sealpette®
 Labpette™
 Nichiryo
 Oxford-Benchmate®
 SMI
 Socorex
 Titertek®

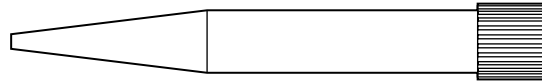

Product No.		Package Type	Qty/	Qty/	Price/
Blue	Natural		Unit	Case	Unit
116	116-N	Bagged	1,000	10,000	\$10.35
116-R	116-RN	Stack Rack - 100	1,000	5,000	17.30
116-R100	116-R100N	100 Tip Rack	1,000	5,000	21.00
116-R100S	116-R100NS	100 Tip Rack - S	1,000	5,000	23.50
116-S	116-NS	Single Wrap - S	500	5,000*	17.00

Volume: 5-250µl

For use with but not limited to:

Biohit Proline®
 Costar® Onepette, 8 & 12 Pette®
 Finnpipette®
 Eppendorf®
 Jencons Sealpette®
 Nichiryo
 Oxford-Benchmate®



Product No.		Package Type	Qty/	Qty/	Price/
Yellow	Natural		Unit	Case	Unit
117	117-N	Bagged	1,000	10,000	\$9.15
117-96R	117-96RN	96 Tip Rack	960	4,800	17.50
117-96RS	117-96RNS	96 Tip Rack - S	960	4,800	19.50

Volume: 1-200µl

For use with but not limited to:

Pipetman®
 Biohit Proline®
 Costar® Onepette, 8 & 12 Pette®
 Eppendorf®
 Finnpipette®
 Jencons Sealpette®
 Labpette™, 8 & 12 Channel
 Nichiryo
 Oxford-Benchmate®
 Rainin EDP2™
 Socorex
 Titertek®
 Volac

Large Orifice Tip



Product No.		Package Type	Qty/	Qty/	Price/
Yellow	Natural		Unit	Case	Unit
118	118-N	Bagged	1,000	10,000	\$9.15
118-R	118-RN	Stack Rack - 200	1,000	10,000	14.75
118-96R	118-96RN	96 Tip Rack	960	4,800	17.50
118-96RS	118-96RNS	96 Tip Rack - S	960	4,800	19.50
118-S	118-NS	Single Wrap - S	500	5,000*	14.50
H-118-96R	H-118-96RN	H 96 Tip Rack	960	4,800	17.50

Standard & Gel Loading

Volume: 101-1000µl

For use with but not limited to:

Pipetman®

Costar®

Eppendorf®

Excalibur

Finnpipette®

Nichiryo

Oxford-Benchmate®

SMI

Socorex

Rainin EDP2™

Titertek®

Volac

Large Orifice Tip

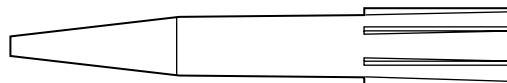

Product No.	Color	Package Type	Qty/ Unit	Qty/ Case	Price/ Unit
119	Natural	Bagged	1,000	10,000	\$10.35
119-R	Natural	Stack Rack - 100	1,000	5,000	17.30
119-R100	Natural	100 Tip Rack	1,000	5,000	21.00
119-R100S	Natural	100 Tip Rack - S	1,000	5,000	23.50
119-S	Natural	Single Wrap - S	500	5,000*	17.00

Large Orifice Extra Long Tip *to ensure maximum sampling*

Volume: 101-1000µl

For use with but not limited to:

Pipetman®

Costar®

Eppendorf®

Finnpipette®

Nichiryo

Oxford-Benchmate®

SMI Airpettor

Socorex

Titertek®

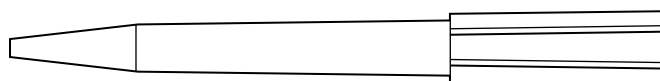

Product No.	Color	Package Type	Qty/ Unit	Qty/ Case	Price/ Unit
119-NXL	Natural	Bagged	1,000	10,000	\$10.55
119-NXL-R100	Natural	100 Tip Rack	1,000	5,000	21.20
119-NXL-R100S	Natural	100 Tip Rack - S	1,000	5,000	23.70

Small MLA Tip

Volume: 5-200µl

For use with but not limited to:

MLA™

Ames

Costar® Onepette

Nichiryo

Oxford-Benchmate®

Pipetman®

SMI Airpettor

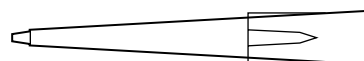

Product No.	Color	Package Type	Qty/ Unit	Qty/ Case	Price/ Unit
120	Natural	Bagged	1,000	10,000	\$9.00
120-R	Natural	Stack Rack - 200	1,000	10,000	14.60
120-R200	Natural	200 Tip Rack	1,000	10,000	18.35
120-R200S	Natural	200 Tip Rack - S	1,000	10,000	21.60
120-S	Natural	Single Wrap - S	500	5,000*	14.50

Pipet Tips

1

Standard & Gel Loading

Volume: 250-1000µl

For use with but not limited to:

MLA®

Large MLA® Tip



Product No.	Color	Package Type	Qty/ Unit	Qty/ Case	Price/ Unit
121	Natural	Bagged	1,000	10,000	\$10.35
121-R	Natural	Stack Rack - 100	1,000	5,000	17.30
121-R100	Natural	100 Tip Rack	1,000	5,000	21.00
121-R100S	Natural	100 Tip Rack - S	1,000	5,000	23.50
121-S	Natural	Single Wrap - S	500	5,000*	17.00

Volume: 100-1300µl

For use with but not limited to:

Matrix

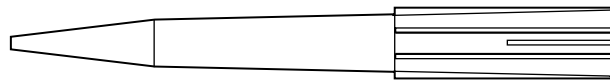

Product No.	Color	Package Type	Qty/ Unit	Qty/ Case	Price/ Unit
122	Natural	Bagged	1,000	10,000	\$11.85
122-96R	Natural	96 Tip Rack	960	4,800	22.50
122-96RS	Natural	96 Tip Rack - S	960	4,800	25.00
122-S	Natural	Single Wrap - S	250	2,500*	9.37

Ultra Micro Gel Loading Tip

Volume: 0.5-10µl

For use with but not limited to:

Eppendorf®

Nichiryo

Oxford-Benchmate®

Socorex

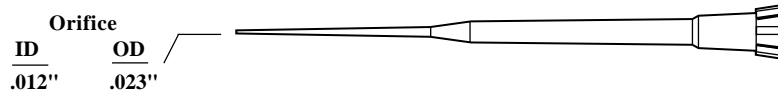

Product No.	Color	Package Type	Qty/ Unit	Qty/ Case	Price/ Unit
123	Natural	Bagged	1,000	10,000	\$18.33
123-R204	Natural	204 Tip Rack	1,632	4,896	42.17
123-R204S	Natural	204 Tip Rack - S	1,632	4,896	45.50
123-S	Natural	Single Wrap - S	500	5,000*	20.57

Ultra Micro Gel Loading Tip

Volume: 0.5-10µl

For use with but not limited to:

Eppendorf®

Nichiryo

Oxford-Benchmate®

Socorex



Product No.	Color	Package Type	Qty/ Unit	Qty/ Case	Price/ Unit
124-R204	Natural	204 Tip Rack	1,020	10,200*	\$80.00
124-R204S	Natural	204 Tip Rack - S	1,020	10,200*	90.00

Standard & Gel Loading

Volume: 25-200µl

For use with but not limited to:

Costar®

Finnpipette®

MLA®

Nichiryo

Oxford-Benchmate®

Pipetman®

Titertek® Digital



Product No.	Color	Package Type	Qty/ Unit	Qty/ Case	Price/ Unit
125	Natural	Bagged	1,000	10,000	\$9.15
125-96R	Natural	96 Tip Rack	960	4,800	17.50
125-96RS	Natural	96 Tip Rack - S	960	4,800	19.50

Volume: 50-1200µl

For use with but not limited to:

Biohit Proline®

Jencons Sealpette®

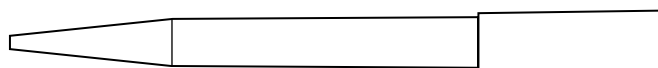

Product No.	Color	Package Type	Qty/ Unit	Qty/ Case	Price/ Unit
126	Natural	Bagged	1,000	10,000	\$11.85
126-96R	Natural	96 Tip Rack	960	4,800	22.50
126-96RS	Natural	96 Tip Rack - S	960	4,800	25.00
126-S	Natural	Single Wrap - S	250	2,500*	9.37

Volume: 50-1500µl

For use with but not limited to:

Titertek® Multi-Stepper

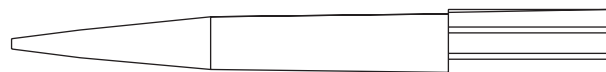

Product No.	Color	Package Type	Qty/ Unit	Qty/ Case	Price/ Unit
127	Natural	Bagged	1,000	10,000	\$11.85
127-96R	Natural	96 Tip Rack	960	4,800	22.50
127-96RS	Natural	96 Tip Rack - S	960	4,800	25.00
127-S	Natural	Single Wrap - S	250	2,500*	9.37

Volume: 1250µl

For use with but not limited to:

Eppendorf®

Repeater™ Plus/8™ (1.25ml)
with Cartridge-B

Reference & Research

100-1000ul

Model 4850 Electronic

500-1000ul

Biohit Proline® 50-1000ul

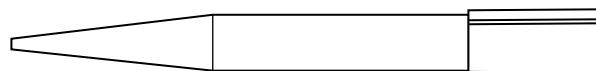

Product No.	Color	Package Type	Qty/ Unit	Qty/ Case	Price/ Unit
128	Natural	Bagged	1,000	10,000	\$11.85
128-96R	Natural	96 Tip Rack	960	4,800	22.50
128-96RS	Natural	96 Tip Rack - S	960	4,800	25.00

Pipet Tips

1

Standard & Gel Loading

Volume: 5-200µl

For use with but not limited to:

Oxford® Sampler 8000
Abbott
Helena®
Pfizer

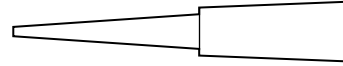

Product No.	Color	Package Type	Qty/ Unit	Qty/ Case	Price/ Unit
130	Natural	Bagged	1,000	10,000	\$9.15
130-R	Natural	Stack Rack - 200	1,000	10,000	14.75
130-R200	Natural	200 Tip Rack	1,000	10,000	18.50
130-R200S	Natural	200 Tip Rack - S	1,000	10,000	21.75

Volume: 250-500µl

For use with but not limited to:

Oxford® Sampler 8000
Abbott
Centrifichem® Analyzer
Helena®
Pfizer



Product No.	Color	Package Type	Qty/ Unit	Qty/ Case	Price/ Unit
131	Yellow	Bagged	1,000	10,000	\$10.35

Volume: 600-1000µl

For use with but not limited to:

Oxford® Sampler 8000
Abbott
Finnpipette®
Helena®
Nichiryo
Oxford-Benchmate®
Pfizer

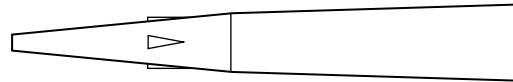

Product No.	Color	Package Type	Qty/ Unit	Qty/ Case	Price/ Unit
132	Green	Bagged	1,000	10,000	\$10.35

Small Slimline Tip

Volume: 1-200µl

For use with but not limited to:

Oxford® Sampler P-3000 & P-7000
Helena®

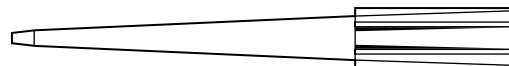

Product No.	Color	Package Type	Qty/ Unit	Qty/ Case	Price/ Unit
135	Natural	Bagged	1,000	10,000	\$10.35
135-R	Natural	Stack Rack - 100	1,000	5,000	17.30
135-S	Natural	Single Wrap - S	500	5,000*	17.00

Standard & Gel Loading

For Automated Liquid Handling refer to page 41

Volume: 5-1000µl

For use with but not limited to:

Finnpipette®

Labpette™

Nichiryo

Oxford-Benchmate®

Oxford® Sampler P-3000 & P-7000

SMI Airpettor

Zymark®

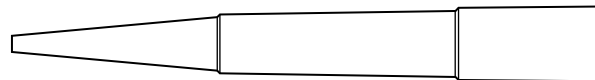

	Product No.	Color	Package Type	Qty/ Unit	Qty/ Case	Price/ Unit
	137	Blue	Bagged	500	5,000	\$5.78
	137-R	Blue	Stack Rack - 100	1,000	5,000	18.60
	137-R100	Blue	100 Tip Rack	1,000	5,000	22.30
	137-R100S	Blue	100 Tip Rack - S	1,000	5,000	24.80

Volume: 10-500µl

For use with but not limited to:

Centaur

Sherwood-Lancer®

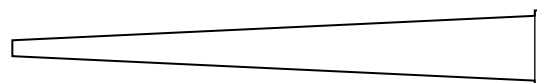

	Product No.	Color	Package Type	Qty/ Unit	Qty/ Case	Price/ Unit
	140	Natural	Bagged	1,000	10,000	\$10.35

Volume: 10-500µl

For use with but not limited to:

Beckman®-Bun,
Glucose Analyzer

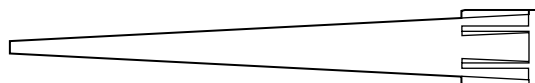

	Product No.	Color	Package Type	Qty/ Unit	Qty/ Case	Price/ Unit
	145	Natural	Bagged	1,000	10,000	\$10.35
	145-R100	Natural	100 Tip Rack	1,000	5,000	21.00

Pipet Tips

1

Standard & Gel Loading

Volume: 300µl

For use with but not limited to:

Biohit Proline®
 Costar® Onepette, 8 & 12 Pette®
 Eppendorf® Ref. 50-200µl
 Eppendorf® Res. 10-200µl
 Finnpiptette® 40-200µl, 50-300µl
 Jencons Sealpette®
 Labpette™
 Pipetman® P-200 50-200µl
 Rainin R-200 50-200µl
 Titertek® 40-200µl, 50-300µl

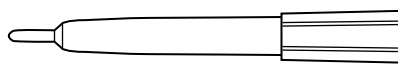

Product No.	Color	Package Type	Qty/ Unit	Qty/ Case	Price/ Unit
169	Natural	Bagged	1,000	10,000	\$10.15
169-96R	Natural	96 Tip Rack	960	4,800	18.50
169-96RS	Natural	96 Tip Rack - S	960	4,800	20.50

Volume: 5-250µl

For use with but not limited to:

Socorex
 Biohit Proline®
 Eppendorf® Reference and
 Research
 Finnpiptette® Digital
 Labpette™
 Nichiryo
 Oxford-Benchmate®
 Rainin EDP2™
 Volac

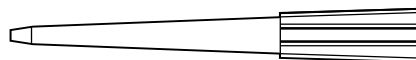

Product No.	Color	Package Type	Qty/ Unit	Qty/ Case	Price/ Unit
177	Natural	Bagged	1,000	10,000	\$10.15
177-R	Natural	Stack Rack - 200	1,000	10,000	15.75
177-96R	Natural	96 Tip Rack	960	4,800	18.50
177-96RS	Natural	96 Tip Rack - S	960	4,800	20.50

For use with but not limited to:

QSP BBL cup (page 91)

Tip for BBL® Fibrometer® Low Density Polyethylene

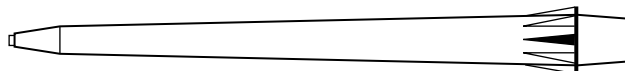

Product No.	Color	Package Type	Qty/ Unit	Qty/ Case	Price/ Unit
210	Natural	Bagged	1,000	10,000	\$12.20 No Discount

Certified RNase, DNase & Pyrogen Free



Tested by an independent laboratory, these pre-sterilized pipet tips are certified to be RNase, DNase and Pyrogen Free within detectable limits.

- Certificate(s) of analysis available upon request.
- Pre-sterilized by Gamma-Cobalt 60 Irradiation.

Ultra Micro Tip

Volume: 0.1-10 μ l

For use with but not limited to:

Pipetman[®]

Biohit Proline[®]

Eppendorf[®] Reference and
Research

Jencons Sealpette[®]

Labpette[™]

Nichiryo

Oxford-Benchmate[®]

Rainin EDP2[™]

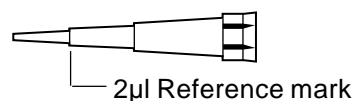

Product No.	Color	Package Type	Qty/ Unit	Qty/ Case	Price/ Unit
C104-96RS	Natural	96 Tip Rack - S	960	4,800	\$25.50

Standard Tip

Volume: 1-200 μ l

For use with but not limited to:

Pipetman[®]

Costar[®] Onepette, 8 & 12 Pette[®]

Eppendorf[®]

Finnpipette[®]

Labpette[™]

Nichiryo

Oxford-Benchmate[®]

Rainin EDP2[™]

Socorex

Titertek[®] Digital

Volac



Product No.	Color	Package Type	Qty/ Unit	Qty/ Case	Price/ Unit
C110-96RNS	Natural	96 Tip Rack - S	960	4,800	\$24.50

Pipet Tips

1

Certified RNase, DNase & Pyrogen Free

Standard Tip

Volume: 101-1000 μ l

For use with but not limited to:

Pipetman[®]

Costar[®]

Eppendorf[®]

Finnpipette[®]

Nichiryo

Oxford-Benchmate[®]

Rainin EDP2[™]

SMI Airpettor

Socorex

Titertek[®]

Volac

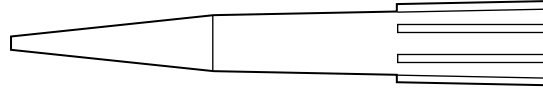

Product No.	Color	Package Type	Qty/ Unit	Qty/ Case	Price/ Unit
C111-R100NS	Natural	100 Tip Rack - S	1,000	5,000	\$28.50

Beveled Orifice Tip *with graduations at 10, 50 & 100 μ l*

Volume: 1-200 μ l

For use with but not limited to:

Pipetman[®]

Costar[®] Onepette, 8 & 12 Pette[®]

Eppendorf[®]

Finnpipette[®]

Labpette[™]

Nichiryo

Oxford-Benchmate[®]

Rainin EDP2[™]

Socorex

Titertek[®] Digital

Volac

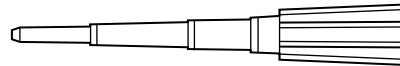

Product No.	Color	Package Type	Qty/ Unit	Qty/ Case	Price/ Unit
C113-96RGNS	Natural	96 Tip Rack - S	960	4,800	\$25.00

Ultra Micro Tip

Volume: 0.5-10 μ l

For use with but not limited to:

Eppendorf[®]

Nichiryo

Oxford-Benchmate[®]

Socorex

Titertek[®] Plus

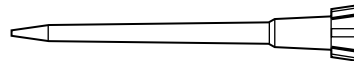

Product No.	Color	Package Type	Qty/ Unit	Qty/ Case	Price/ Unit
C114-R100S	Natural	100 Tip Rack - S	1,000	5,000	\$24.50

Low Adhesion

For those applications where optimal yield and minimal sample loss are required.

Low Adhesion Pipet Tips are injection molded with scientifically blended resins to minimize liquid retention and ensure optimal sample yield. This advanced technique eliminates the use of lubricants that may be harmful to priceless samples. Tips are autoclavable using standard autoclaving guideline shown on page 98.

Our Superior Quality Low Adhesion Pipet Tips are ideal for DNA and PCR* applications as well as sensitive clinical assays, quantitative analysis, quality control or any other applications where optimal yield and minimal sample loss is required. Customers can select from six different pipet tips with volume ranges from 0.1µl to 1000µl.

*PCR process is covered by patents owned by Hoffman-LaRoche Inc.

Ultra Micro Tip

Volume: 0.1-10µl

For use with but not limited to:

Pipetman®

Biohit Proline®

Eppendorf® Reference and Research

Jencons Sealpette®

Labpette™

Nichiryo

Oxford-Benchmate®

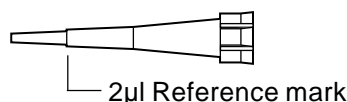

Product No.	Color	Package Type	Qty/ Unit	Qty/ Case	Price/ Unit
104-SC	Natural	Bagged	500	5,000	\$5.58
104-96R-SC	Natural	96 Tip Rack	960	4,800	20.50
104-96R-SC-S	Natural	96 Tip Rack - S	960	4,800	22.50
H-104-96R-SC	Natural	H 96 Tip Rack	960	4,800	20.50
H-104-96R-SC-S	Natural	H 96 Tip Rack - S	960	4,800	21.50

Beveled Orifice Tip

Volume: 1-200µl

For use with but not limited to:

Pipetman®

Costar® Onepette, 8 & 12 Pette®

Eppendorf®

Finnpipette®

Labpette™

Nichiryo

Oxford-Benchmate®

Rainin EDP2™

Socorex

Titertek® Digital

Volac

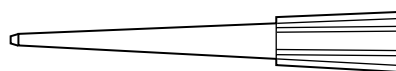

Product No.	Color	Package Type	Qty/ Unit	Qty/ Case	Price/ Unit
110-BN-SC	Natural	Bagged	500	5,000	\$5.58
H-110-96RBN-SC	Natural	H 96 Tip Rack	960	4,800	20.50
H-110-96RBN-SC-S	Natural	H 96 Tip Rack - S	960	4,800	21.50

Pipet Tips

1

Low Adhesion

For those applications where optimal yield and minimal sample loss are required.

Volume: 101-1000µl

For use with but not limited to:

Pipetman®
 Costar®
 Eppendorf®
 Finnpiquette®
 Nichiryo
 Oxford-Benchmate®
 Rainin EDP2™
 SMI Airpette®
 Socorex
 Titertek®
 Volac

Standard Tip

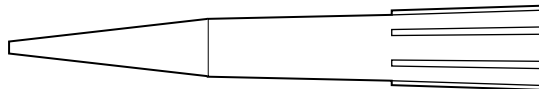

Product No.	Color	Package Type	Qty/ Unit	Qty/ Case	Price/ Unit
111-N-SC	Natural	Bagged	500	5,000	\$6.18
H-111-R100N-SC	Natural	H 100 Tip Rack	1,000	5,000	25.50
H-111-R100N-SC-S	Natural	H 100 Tip Rack - S	1,000	5,000	28.50

Volume: 101-1000µl

For use with but not limited to:

Pipetman®
 Costar®
 Eppendorf®
 Finnpiquette®
 Nichiryo
 Oxford-Benchmate®
 Rainin EDP2™
 SMI Airpette®
 Socorex
 Titertek®
 Volac

Graduations at 250, 500, & 1000µl

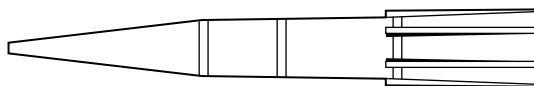

Product No.	Color	Package Type	Qty/ Unit	Qty/ Case	Price/ Unit
112-GN-SC	Natural	Bagged	500	5,000	\$6.43
112-R100GN-SC	Natural	100 Tip Rack	1,000	5,000	23.50
112-R100GN-SC-S	Natural	100 Tip Rack - S	1,000	5,000	26.00

Volume: 1-200µl

For use with but not limited to:

Pipetman®
 Costar® Onepette, 8 & 12 Pette®
 Eppendorf®
 Finnpiquette®
 Labpette™
 Nichiryo
 Oxford-Benchmate®
 Rainin EDP2™
 Socorex
 Titertek® Digital
 Volac

Beveled Orifice Tip with graduations at 10, 50 & 100µl

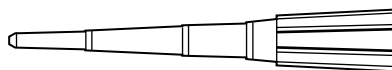

Product No.	Color	Package Type	Qty/ Unit	Qty/ Case	Price/ Unit
113-GN-SC	Natural	Bagged	500	5,000	\$5.83
113-96RGN-SC	Natural	96 Tip Rack	960	4,800	20.00
113-96RGN-SC-S	Natural	96 Tip Rack - S	960	4,800	22.00
HRI-113-GN-SC	Natural	H 96 Tip Rack - Insert	480	4,800	9.50
H-113-96RGN-SC	Natural	H 96 Tip Rack	960	4,800	20.10
H-113-96RGN-SC-S	Natural	H 96 Tip Rack - S	960	4,800	22.00

Volume: 0.5-10µl

For use with but not limited to:

Eppendorf®
 Nichiryo
 Oxford-Benchmate®
 Socorex
 Titertek® Plus

Ultra Micro Tip

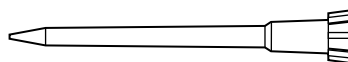

Product No.	Color	Package Type	Qty/ Unit	Qty/ Case	Price/ Unit
114-SC	Natural	Bagged	500	5,000	\$5.58
114-R100-SC	Natural	100 Tip Rack	1,000	5,000	19.50
114-R100-SC-S	Natural	100 Tip Rack - S	1,000	5,000	21.50
H-114-96R-SC	Natural	H 96 Tip Rack	960	4,800	20.00
H-114-96R-SC-S	Natural	H 96 Tip Rack - S	960	4,800	22.00

24

w - with
 w/o - without

H - Hinged
 S - Sterile

* - may be purchased by the unit

QLS[®] Quality Loading System

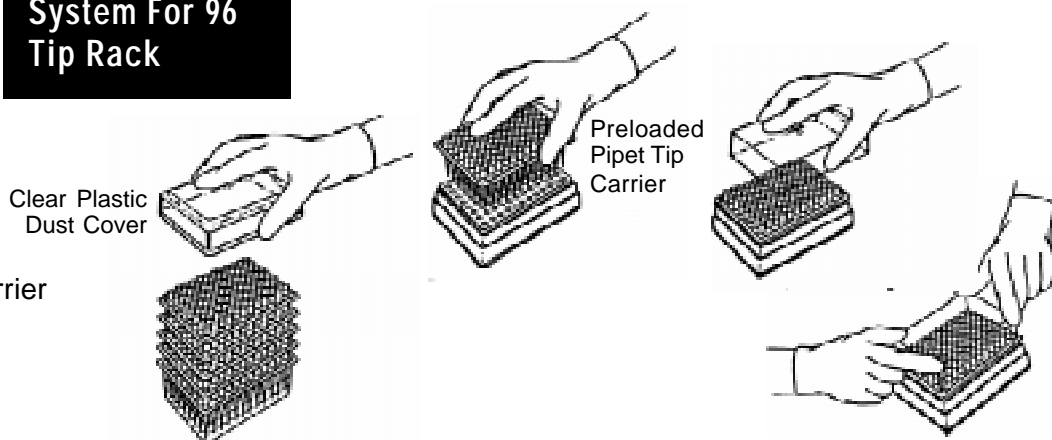

Note: Pipet Tip Carrier is autoclavable.
Do Not autoclave Blister Pack.

QLS[®] is our economical, easy to use, environmentally conscious solution to tip racking; the problems associated with empty racks and the amount of plastic labs are throwing away. The demand for this type of product is ever increasing, as more and more people become committed to the preservation of our environment.

Patented Design

Our patented tip carrier has 96 tips securely locked into place for easy alignment with the rack. Tips are easily released with pressure on the corners of the carrier using four fingers or a dust cover.

Easy to Use

Each unit of QLS[®] consists of five preloaded tip carriers, 96 tips each, nested in a blister pack. Easy to follow directions are pre-printed on each sleeve and the entire unit is shrink wrapped. With ease and speed, one to five racks are loaded at a time.

Economic

Priced lower than pre-racked tips, immediate savings are realized by reloading empty racks that have already been paid for. Additional savings are also gained through the reduction of valuable storage space.

Environmentally Conscious

QLS[®] eliminates 80% of plastic waste. In addition, all materials used in the manufacture of our loading system are recyclable. Both are significant steps toward the preservation of our environment.

Versatile

Although designed specifically for use with QSP[®] racks, our Quality Loading System is compatible with a number of other racks. Three styles of empty QSP[®] racks are available (see page 27) for those who need replacements. Our racks are designed to withstand numerous autoclave cycles.

QLS is a Registered Trademark of Quality Scientific Plastics
U.S. Patent 5,487,997

Pipet Tips

1

QLS® Quality Loading System

Volume: 1-200µl

For use with but not limited to:

Pipetman®

Costar® Onepette, 8 & 12 Pette®

Eppendorf®

Finnpipette®

Labpette™

Nichiryo

Oxford-Benchmate®

Rainin EDP2™

Socorex

Titertek® Digital

Volac

Standard Orifice Tip

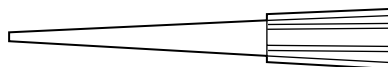

Product No.	Color	Package Type	Qty/ Unit	Qty/ Case	Price/ Unit
QLS-110	Yellow	QLS	480	4,800	\$8.00
QLS-110-N	Natural	QLS	480	4,800	8.00

Volume: 1-200µl

For use with but not limited to:

Pipetman®

Costar® Onepette, 8 & 12 Pette®

Eppendorf®

Finnpipette®

Labpette™

Nichiryo

Oxford-Benchmate®

Rainin EDP2™

Socorex

Titertek® Digital

Volac

Beveled Orifice Tip

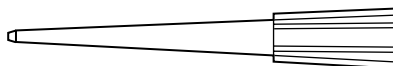

Product No.	Color	Package Type	Qty/ Unit	Qty/ Case	Price/ Unit
QLS-110-B	Yellow	QLS	480	4,800	\$8.00
QLS-110-BN	Natural	QLS	480	4,800	8.00

Volume: 1-250µl

For use with but not limited to:

Pipetman®

Costar® Onepette, 8 & 12 Pette®

Eppendorf®

Finnpipette®

Labpette™

Nichiryo

Oxford-Benchmate®

Rainin EDP2™

Socorex

Titertek® Digital

Volac

Thin Wall Orifice Tip



Product No.	Color	Package Type	Qty/ Unit	Qty/ Case	Price/ Unit
QLS-TW110-N	Natural	QLS	480	4,800	\$8.00

Volume: 1-200µl

For use with but not limited to:

Pipetman®

Costar® Onepette, 8 & 12 Pette®

Eppendorf®

Finnpipette®

Labpette™

Nichiryo

Oxford-Benchmate®

Rainin EDP2™

Socorex

Titertek® Digital

Volac

Beveled Orifice Tip with graduations at 10, 50 & 100µl

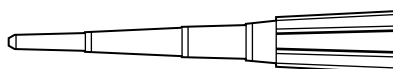

Product No.	Color	Package Type	Qty/ Unit	Qty/ Case	Price/ Unit
QLS-113-G	Yellow	QLS	480	4,800	\$8.00
QLS-113-GN	Natural	QLS	480	4,800	8.00

Robotic Tips

Zymark® Automation Certified® Tempo™ Pipet Tips



The QSP brand has been combined with Zymark's engineering excellence to produce the first Automation Certified tip and rack system for Zymark automated liquid handling systems.

Designed to assure reliable operation with Zymark's RapidPlate® 96 & RapidPlate® 96/384 and all Micro Assay modules and workstations, this is the **only tip and rack system recommended by Zymark®**.

• Tightly controlled manufacturing process provides uniformity from rack to rack

- Trouble free performance with Zymark® automation hardware
- Compatible with existing Zymark® Micro Assay modules

Minor modification to Easy Lab software may be necessary due to increased length of tips. If assistance is needed, call Zymark's Zyline: (508) 435-9761

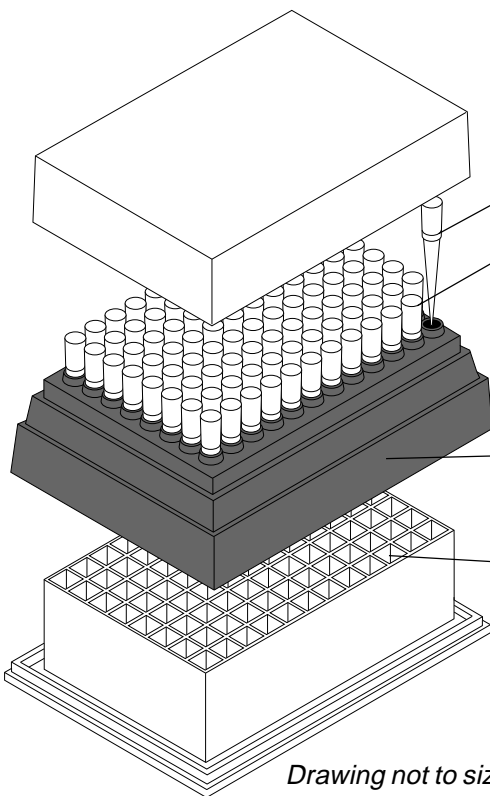

Drawing not to size

Exclusively
Manufactured
by QSP®.

- 100µl & 200µl capacity tips
- Improved attachment entry point enhances reliability of the seal, improving dispensing accuracy
- Rigid box design ensures reliable tip attachment
- Individual compartments for each tip, preventing cross-contamination

Cross Reference:	
QSP®	Zymark®
159	68037
159-96R	66670
159-96RS	68036
LMF159-96RS-80	68759
BLK-159-96R	68892
BLK-159-96RS	68924
BLK-LMF159-96RS-80	72308

Cross Reference:	
QSP®	Zymark®
160	57203
160-96R	56362
160-96RS	56977
LMF160-96RS-150	68921
BLK-160-96R	65408
BLK-160-96RS	68891
BLK-LMF160-96RS-150	72309

Volume: 100µl

Polypropylene

For use with but not limited to:

Zymark®



Product No.	Color	Package Type	Qty/ Unit	Qty/ Case	Price/ Unit
159	Natural	Bagged	1,000	10,000	\$10.65
159-96R	Natural	96 Tip Rack	960	4,800	21.50
159-96RS	Natural	96 Tip Rack - S	960	4,800	23.50

* - may be purchased by the unit

Robotic Tips

For use with:

Beckman® Biomek 1000/2000

Interchangeable Liquid Handling Tools and Beckman Manual Pipetters

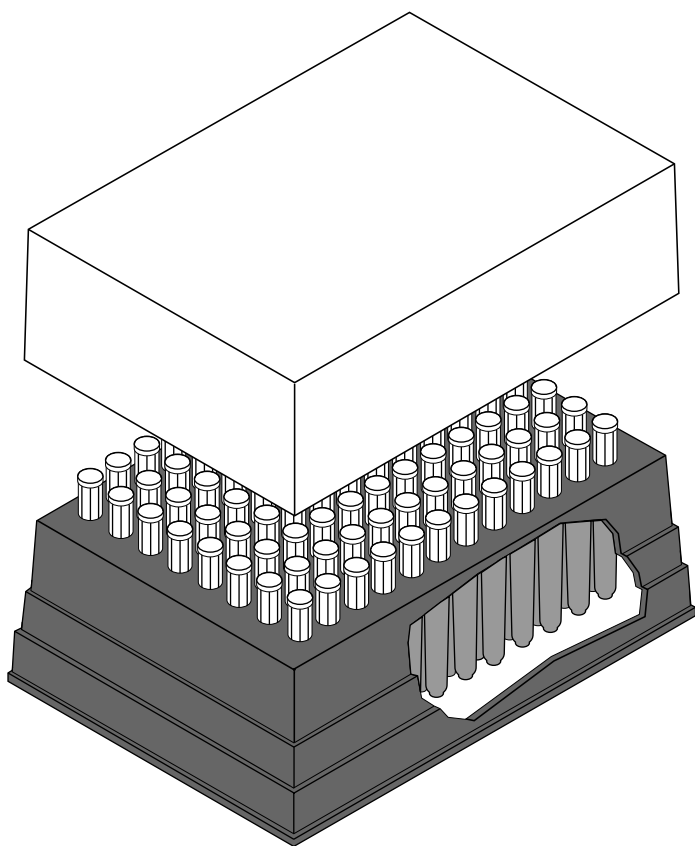

Robotic

A slight rocking motion is generally used to seat tips onto a hand held multichannel pipetter. Automated liquid handling systems rely on force, which can cause flexing in the rack and improper seating of the tips. The QSP® “robotic compatible rack” is specifically designed to withstand extreme force, ensuring reliable attachment of all 96 tips. Individual interior rack compartments isolate each tip eliminating the possibility of cross-contamination.

Tips

Manufactured of virgin, non-wettable, polypropylene material, QSP pipet tips reduce fluid retention and optimize instrument performance. Robot compatible (large micron), hydrophobic filter effectively eliminates instrument contamination caused by aerosol formation during pipetting procedures.

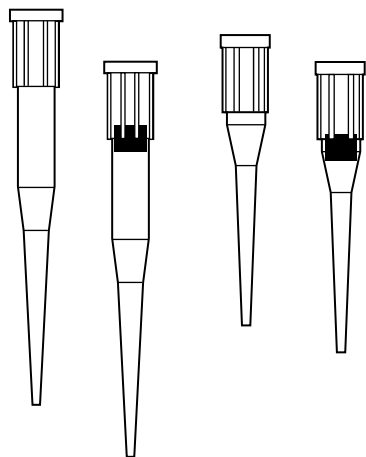

Pre-sterilized (Gamma Radiation) Certified RNase, DNase and Pyrogen free; also metal free.



Non-sterilized: Certified RNase, DNase free; also metal free.

Robotic Tips

Liquid-Level Sensing

Many well known automated liquid handling systems use liquid-level sensing (Black) tips.

For use with but not limited to equipment from these manufacturers:

- Tecan
- Rosys Inc.
- Hamilton Co.
- Packard Instrument Co.

We began manufacturing **Liquid-Level Sensing Tips** for a progressive automated liquid handling equipment manufacturer who was working on a new concept. Today, many well known systems are equipped to use disposable tips in addition to washable probes. Disposable tips are necessary for critical assays where zero carry-over is imperative.

Although standard polypropylene pipet tips can be used with some systems, the majority require (tips manufactured of) **carbon black-conductive polypropylene**. This highly conductive material is necessary to detect the presence or absence of sufficient liquid, in order to avoid short sampling and excessive submersion of the tip during aspiration. The QSP® Liquid-Level Sensing Tips are specifically manufactured for this purpose.

To achieve optimal fit and function with the various standard and customized automated liquid handling systems, QSP offers a wide selection of Liquid-Level Sensing Tips ranging in volumes from 10µl to 1000µl.

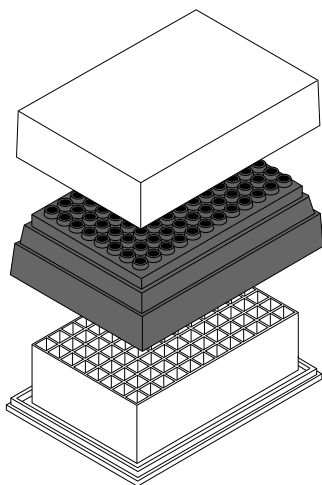

Some automated liquid handling systems require more force than ordinary pipettors to seat the tips. The additional force can cause flexing in the rack and improper seating of the tips. Our optional heavy duty rack features 96 full height individual inner compartments which provide additional stability. As an added benefit, these inner compartments serve to keep the tips separated from each other, eliminating the possibility of cross contamination.

Completed with our popular lift-off cover, the entire unit is fully autoclavable*.

* Refer to section 6 for recommended autoclaving instructions.

Volume: 0.1-10µl



Product No.	Color	Package Type	Qty/ Unit	Qty/ Case	Price/ Unit
BLK-104	Black	Bagged	1,000	10,000	\$15.15
BLK-104-96R⁺	Black	96 Tip Rack	960	4,800	24.50
BLK-104-96RS⁺	Black	96 Tip Rack - S	960	4,800	26.50

*Available in 96 Tip Heavy Duty Compartment Rack. Please add "2" after product number and increase price \$2.00 per unit.